



The Mercedes-Benz Sprinter.

Prices effective from June 2024.

Mercedes-Benz





Contents

➤ Model overview	3
➤ Trims	
➤ Panel Van BASE	4
➤ Panel Van PRO	5
➤ Panel Van SELECT	6
➤ Sprinter Chassis Cab BASE	7
➤ Sprinter Chassis Cab PRO.	8
➤ Sprinter Chassis Cab SELECT	9
➤ Colours and Upholstery	10
➤ Wheels	11
➤ MBUX infotainment system	12
➤ Equipment	13
➤ Engine and gearbox	20
➤ Fuel consumption	21
➤ Weights and payloads	22
➤ Dimensions	23
➤ List prices	30
➤ After sales	32

Please note

This document provides information about the model range line-up and specifications of the Sprinter. It also contains key details about options, economy and performance of all variants. Details are correct at time of publication and are subject to revision. Any images used in this document may not reflect Irish specification and are for illustrative purposes only. Images may show optional equipment which does not form part of Irish standard specification.

The Mercedes-Benz Sprinter.



Panel Van –3 seats



Chassis Cab –3 seats

Available in 2 emission categories:
Euro 6e (Light duty)
Euro VI (Heavy duty)

2 van models:



Standard 5932mm.



Long 6967mm.



Extra Long 7376mm.

3 lengths:



Standard roof 2356mm.



High roof 2638mm.

2 heights

Discover more about the other Mercedes-Benz Sprinter models in our range

The Sprinter Panel Van BASE.

Features included as standard in the BASE Sprinter Panel Van:

Interior

- Multi-function steering wheel
- Co-driver's double seat
- Eco Start/Stop
- Digital radio (DAB)
- Full-width partition
- Cruise Control

Exterior

- Headlight assistant
- Sliding left door
- Rear doors opening to sidewall
- Electrically adjustable heated mirrors

Safety, security and connectivity

- Active Brake Assist
- Blind Spot Assist
- Active Lane Keeping Assist
- Crosswind ASSIST
- Intelligent Speed Assistant
- Attention Assist
- Rain Sensor
- Adaptive Brake Lights
- Breakdown management
- Reversing camera
- MBUX multimedia system with 10.25-inch touch screen

From €50,920*

*Based on a 311.36 3.5t (LOW ROOF) SBASE

*16-inch Steel wheels with Mercedes-Benz centre caps as standard.



[Sprinter Panel Van](#)

[Sprinter Chassis Cab](#)

[MBUX](#)

[Equipment](#)

[Engine and gearbox](#)

[Fuel consumption](#)

[Weights and payloads](#)

[Dimensions](#)

[List prices](#)

The Sprinter Panel Van PRO.

Additional features included with Sprinter Panel Van PRO (addition to BASE):

- USB Socket 5v
- Height and rake adjustable steering wheel
- Hill start assist
- Air conditioning TEMPMATIC
- Fuel tank capacity increase to 93 litres
- Towing eye
- Entrance handle on LH rear corner pillar

From €53,445*

*Based on a 311.36 3.5t (LOW ROOF) S PRO

*16"inch Steel wheels with Mercedes-Benz centre caps as standard.



[Sprinter Panel Van](#)

[Sprinter Chassis Cab](#)

[MBUX](#)

[Equipment](#)

[Engine and gearbox](#)

[Fuel consumption](#)

[Weights and payloads](#)

[Dimensions](#)

[List prices](#)

The Sprinter Panel Van SELECT.

Additional features included with Sprinter Panel Van SELECT (Addition to PRO):

- Leather Steering Wheel
- Radiator grille frame in vehicle colour
- Charging package on dashboard
- Cup holders, front
- Hinged lid on dashboard stowage compartment
- Electrically powered hot air auxiliary heater
- Highbeam assist
- Comfort overhead control panel
- LED high performance headlamps
- Front Mudflaps
- Rear Mudflaps
- Armrest for driver's seat
- Comfort driver's seat
- Lumbar support, driver's seat
- Convenience head restraint, driver's seat

From €56,690*

*Based on a 315.36 3.5t (LOW ROOF) S SELECT

*16" inch Steel wheels with Mercedes-Benz centre caps as standard.



[Sprinter
Panel Van](#)

[Sprinter
Chassis Cab](#)

[MBUX](#)

[Equipment](#)

[Engine and gearbox](#)

[Fuel consumption](#)

[Weights and
payloads](#)

[Dimensions](#)

[List prices](#)

The Sprinter Chassis Cab BASE.

Features included as standard in the Sprinter Chassis Cab BASE:

Interior

- Multi-function steering wheel
- Co-driver's double seat
- Eco Start/Stop
- Digital radio (DAB)
- Cruise Control

Exterior

- Headlight assistant
- Electrically adjustable heated mirrors
- Extended mirror brackets
- Pre-installation 3rd brake light

Safety, security and connectivity

- Active Brake Assist
- Pre-installation Blind Spot Assist
- Active Lane Keeping Assist
- Crosswind ASSIST
- Intelligent Speed Assistant
- Attention Assist
- Rain Sensor
- Adaptive Brake Lights
- Breakdown management
- Pre-wiring reverse camera with interior mirror display
- MBUX multimedia system with 10.25-inch touch screen

From €54,345*

*Based on a Sprinter 5 15.43 3.5t L Chassis Cab



The Mercedes-Benz Sprinter

The Sprinter Chassis Cab PRO.

Additional features included with the Sprinter Chassis Cab PRO:

- Large fuel tank 93 litres
- USB Socket 5V
- Hill start assist
- Air Conditioning TEMPMATIC
- Height and rake adjustable steering wheel

From €57,005*

*Based on a Sprinter 5 15.43 3.5t L Chassis Cab



[Sprinter Panel Van](#)

[Sprinter Chassis Cab](#)

[MBUX](#)

[Equipment](#)

[Engine and gearbox](#)

[Fuel consumption](#)

[Weights and payloads](#)

[Dimensions](#)

[List prices](#)

The Sprinter Chassis Cab SELECT.

Additional features included with the Sprinter Chassis Cab SELECT:

- Leather steering wheel
- Radiator grille frame in vehicle colour
- Hinged lid on dashboard stowage compartment
- Cup holders, front
- Charging package on dashboard
- Electrically powered auxiliary hot air heater
- High-beam assist
- Comfort overhead control panel
- LED high performance headlights
- Front mud flaps
- Armrest for driver's seat
- Comfort driver's seat
- Lumbar support, driver's seat
- Convenience head restraint, driver's seat

From €60,500*

*Based on a Sprinter 5 1 5.43 3.5t L Chassis Cab



The Mercedes-Benz Sprinter

9

Sprinter
Panel Van

Sprinter
Chassis Cab

MBUX

Equipment

Engine and gearbox

Fuel consumption

Weights and
payloads

Dimensions

List prices

Colours and upholstery.

Solid paints



Arctic White



Jupiter Red



Steel Blue



Blue Grey



Jet Black

Metallic paints



Cavanaugh Blue Metallic



Tenorite Grey Metallic



Selenite Grey Metallic



Obsidian Black Metallic



High-Tech Silver Metallic

Interior upholstery

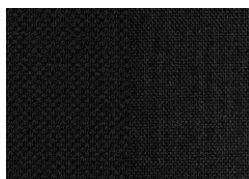

Maturin black fabric



Caluma black fabric

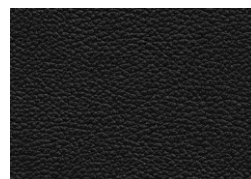

Black ARTICO man-made leather

➤ [For paint pricing, see page 10](#)

➤ [For upholstery pricing, see page 12](#)

Wheels.

Our upgraded wheel options include:

1. 40.6 cm (16-inch) 6-spoke light-alloy wheels, painted in vanadium silver (RL5)
2. 43.2 cm (17-inch) light-alloy wheels (RL7)

Please note, more wheel options are available -[see page 12](#) for more information. Consult your local Dealer for the full range of wheels available.

> [Find your nearest Dealership](#)



MBUX - the Mercedes-Benz User Experience infotainment system.

With MBUX (Mercedes-Benz User Experience), you get an intelligent and expandable multimedia system. Its various interfaces and high-resolution touchscreen offer numerous communication and infotainment functions.

10.25-inch (standard)

- 'Hey Mercedes', Voice Command Operation
- Fully integrated navigation system with Live Traffic, VentoX Communication and 3D map display with the Mercedes Me connect Advanced Navigation Package
- What3words a geocoded map system offering more accurate location services – integrated into the in-ven navigation systems. Drivers with compatible models can now say or type in a 3 word address to get directions to a precise 3m x 3m location, anywhere in the world.
- A Bluetooth® interface with hands-free function allows you to make phone calls while driving, without taking your hands off the steering wheel.



*Wi-Fi hotspot requires a separate data contract with Vodafone, which can be purchased through the MBUX head unit.

Equipment (standard and optional overview).

Equipment	Description	Option Code	RRP incl. VAT
Exterior Features			
Bodywork	Bumper and corner bumpers, paintable	C72	€403
	Painted Bumpers (4 Colours)	CM0	€633
	Front bumper painted in vehicle colour	CN3	€517
	Body Raised	CE8	€305
	Extra High Roof	D06	€3,213
	Mounting Rails for Roof Rack	D13	€271
	Chrome Radiator Grille	FK3	€266
	Sliding Door Right	T16	€1,230
	Entrance Door Handle Driver and Co-Driver	T75	€85
	Entrance Door Handle Rear Left Side	T85	€52
	Sliding Door Deleted	T93	€0
	Bulkhead Panelling	V07	€238
	Exhaust Pipe to Rear	K60	€105
	Exhaust Pipe Ending Before Rear Axle	K63	€140
	Radiator Grille Painted	CN2	€92
Fuel Tank	Fuel Tank 50l	K11	€0
	Fuel Tank 93l	KB7	€336
Paint	Option	Paint	€530
	Special	Paint	€1,276
	Metallic	Paint	€1,672
Tyres	All Season Tyres	RM0	€0
			€124
	Mud & Snow Tyres	RM1	€93
			€190
	Tyre Pressure Monitor	RY2	€411

Equipment (standard and optional overview).

Equipment	Description	Option Code	RRP incl. VAT
Exterior Features			
Wheels	Full Wheel Cover	RD8	€85
	Alloy Wheel 6.5 J x 16	RL5	€1130
	Alloy Wheel 6.5 j x 17 & RH3	RL7	€1219
	Front Mud Flaps	P47	€59
	Rear Mud Flaps	P48	€59
Chassis	Front Axle Upgraded	A50	€310
	Two Leaf Spring / Std on 4325mm	CB1	€387
	Stabilisation level 1	CB7	€369
	Vibration Damper	CT1	€105
Interior Features			
Flooring	Wooden Floor	V43	€682
			€937
	Plastic Flooring	VK8	€566
	Cover for Wheel House (see V52)	V35	€76
	Side Wall Tie Down Rails Waist High	V42	€338
			€467
	Wheel Arch Suitable for Loading	V52	€448
	Load Trim up to Roof	VA2	€1,070
			€1,312
	Interior Trim up to Roof Washable	VA3	€621
			€799

Equipment (standard and optional overview).

Equipment	Description	Option Code	RRP incl. VAT
Interior Features			
	Storage Nets on Rear Doors	VA7	€109
	Side Wall Tie Down from Waist to Roof	VC4	€317
			€448
	Load Securing Rail System	W2	€352
			€452
	Tensioning Straps for Tie Down Rails	YK4	€93
Gearbox	Automatic Transmission 9 Speed	GK8	€2,432
	Pre Installation for Gearbox Cooler	GK4	€278
Heating & ventilation	Heating for Passenger Seat	H15	€298
	Heating for Drivers Seat	H16	€218
	Heat Insulation Glass	H20	€171
	Heat Insulation Glass with Green Band	H21	€214
	Rear Door Glass Heated	H22	€178
	Rear Electric Roof Fan	H72	€571
	Ventilating Equipment with Filter	H81	€133
	Thermotronic Automatic Climate Control	HH4	€2,828
	Air Conditioning	HH9	€2,103
	Heater Booster	HZ9	€840
Seating	Passenger Comfort Seat	SB2	€176
	Lumbar Support Driver Seat	SE5	€91
	Arm Rest Driver / Passenger Door	S28	€59
	Thorax Side Bag Driver	SH1	€425
	Thorax Side Bag Passenger	SH2	€299
	Window Bag for Driver & Passenger	SH9	€1,001
	Convenience Head Restraint Drivers Seat	SK0	€70

Equipment (standard and optional overview).

Equipment	Description	Option Code	RRP incl. VAT
Interior Features			
	Caluma Black	VF4	€104
	Artico Black Man Made Leather	VF6	€104
Steering Wheel	Leather Steering Wheel & Shift Lever	CL2	€254
	Leather Steering Wheel Auto	CL3	€210
	Height and Reach Adjustable Steering Column	CL1	€142
	Handbrake Lever Folding	BE2	€69
In Cab	Fixed sky light in load compartment	D22	€377
	Access for Body Builder signals in cockpit	E2A	€39
	Plug Socket in Cab	E46	€71
	12v in Load Compartment	ES2	€71
	Din Slot under Dash Passenger Side	FE9	€101
	Shelf Above Trim	FF4	€224
	Shelf Above Windscreen	FF5	€152
	Single Slot at Front Under Roof Liner	FF8	€101
	Hinged Lid Centre on Dash	FJ1	€115
	Hinged Lid Left & Right on Dash	FJ5	€242
Technology, software & electrics			
Alternator	Alternator 250amp	M60	€842
	PTO with Bracket for Additional Alternator	N62	€549
	Variable electronic engine speed control	MT4	€492
Audio Entertainment & Navigation			
	Navigation with E3M	E1E	€856
	MBUX Multimedia 10.7 inch screen inc Command	E4M	€1,452

Equipment (standard and optional overview).

Equipment	Description	Option Code	RRP incl. VAT
Interior Features			
Keys	Muti Function Remote Control	FY7	€37
	Two Additional Keys	FZ9	€151
Technology	Tray for Smart Phone Charging	E1B	€186
	PTO without Flange	N05	€2,047
	PTO with Flange	N07	€2,154
	PTO with Bracket for Additional Alternator	N62	€549
	PTO for Fridge	N63	€517
	Locking Device for PTO	N80	€109
Driver assistance & safety			
Driver assistance & safety			
Driver assistance	Electric Parking Brake	B25	€336
	Active Brake Assist	BA3	€517
	Hill Start Assist	E07	€109
	Active Distance DISTRONIC / with Auto Only & CL3 & JK5	ET4	€712
	Blind Spot Assist	JA7	€540
	Active Lane Keeping assist	JB4	€517
	Rain Sensor	JF1	€128
	Reverse Buzzer	JW0	€212
	Attention Assist	JW8	€59
	Cruise Control	MS1	€336
	Speed Limiter 120km	MD3	€165
	Speed Limiter 90km	MD4	€165
	Speed Limiter 100km	MD5	€165
	Speed Limiter 130km	MK2	€165
Speedo MPH /KM	J11	€0	
Parking	Parking Package 360 degree	JB6	€1,203
	Parking Package with Reverse Camera	JB7	€905

Equipment (standard and optional overview).

Equipment	Description	Option Code	RRP incl. VAT
Loading & towing			
Towing & equipment	Trailer Coupling with Mouth 243/U 115 (Incorporates E43 & E07)	Q20	€725
	Trailer Coupling Rigid (Incorporates E43 & E07)	Q22	€651
	Trailer Coupling Ball Head Removeable (Incorporates E43 & E07)	Q50	€676
	Trailer Coupling Ball Head Removeable (Incorporates E43 & E07)		€655
	Trailer Coupling Capacity 3.5t (Includes E43 & E07 & AR5)	QA7	€1,588
	Trailer Coupling Capacity 2.8 / 3.0t (Includes E43 & E07 & AR3)	QA8	€1,306
Mirrors & windows			
Mirrors & windows			
Mirrors	Interior Mirror	F61	€158
	Folding Mirrors	F64	€59
	Mirrors without Indicators	FU5	€133
Windows	Heated Windscreen	F49	€776
	Window in Bulkhead	D51	€93
	Windows in Rear Doors	W61	€310
	Rear Wash Wipe	W78	€362

Equipment (standard and optional overview).

Equipment	Description	Option Code	RRP incl. VAT
Driver assistance & safety			
Safety equipment	Anti Theft Package	FY1	€823
	Anti Theft Warning System	FZ5	€288
	Passenger Air Bag	SA6	€512
	First Aid Kit	Y10	€56
	Fire Extinguisher	Y16	€140
Lighting			
Lighting	Fog Lights with Cornering Function	L13	€241
	Partial LED rear lights	L22	€255
	Interior Lights with Door Contact	L65	€85
	Motion Sensor Controlled Rear Lights	L71	€140
	High Beam Assist	LA1	€330
	Additional Indicators on Roof	LB3	€185
	Rotating Beacons	LB7	€717
	Exit Lights	LB9	€72
	LED Rear Lights in Load Compartment	LC2	€403
	LED High Performance Headlamps	LG7	€1,720
	Pre Installation for Beacons	LV1	€178

Engine and gearbox.

	Euro 6d-TEMP			EuroVI
	311	315	317	319
Fuel	Diesel			Diesel
Mixture preparation/ injection method	Common-rail direct injection with twin stage turbocharging			Common-rail direct injection with twin stage turbocharging
Cylinder arrangement	4, In-line			4, In-line
Cubic capacity	1,950 cc			1,950 cc
EJ exhaust emission standard	Euro 6d-TEMP			EuroVI
Output, max. at 3,800rpm	114hp	150hp	170hp	190hp
	84kW	110kW	125kW	140kW
Torque, max.	300Nm	340Nm	400Nm	450Nm
Fuel tank capacity RWD	71 litres			71 litres
AbBlue ® capacity	22 litres			22 litres
6-speed manual transmission	●	●	●	●
9G-TRONIC	○	○	○	○
Real-wheel drive	●	●	●	●
Alternator	14V/200A			14V/200A
Battery	12V/92Ah (AGM)			12V/92Ah (AGM)

● Standard ○ Optional – Not available

Fuel consumption, performance and CO₂ emissions.

Euro 6d-TEMP

Model	Emissions	Combined	Low Speed	Medium Speed	High Speed	Extra High Speed
	CO ₂ g/km	L/100km	L/100km	L/100km	L/100km	L/100km
FWD						
211.32 High roof	237	9	10	8.3	7.6	10.4
211.32 low roof	231	8.8	9.9	8.2	7.3	10.1
211.39 high roof	239	9.1	10.1	8.4	7.7	10.4
211.39 low roof	233	8.9	10	8.3	7.4	10.2
214.32 high roof	237	9	9.8	8	7.8	10.4
214.32 low roof	229	8.7	9.7	7.9	7.5	9.9
214.39 high roof	240	9.2	10	8.2	7.9	10.5
214.39 low roof	232	8.8	9.9	8	7.6	10
311.32 High roof	240	9.2	10.3	8.5	7.8	10.4
311.32 low roof	234	8.9	10.2	8.4	7.5	10.1
311.39 high roof	242	9.2	10.4	8.6	7.9	10.4
311.39 low roof	236	9	10.3	8.5	7.6	10.1
314.32 high roof	242	9.2	10.1	8.3	7.9	10.6
314.32 low roof	234	8.9	10	8.1	7.7	10
314.39 high roof	245	9.3	10.2	8.4	8	10.7
314.39 low roof	237	9	10.1	8.2	7.8	10.1
RWD						
311.36 CDI VAN Low roof	234	8.9	9.4	8	7.7	10.5
311.36 CDI VAN (3500KG)	241	9.2	9.5	8.1	8	10.9
315.36 CDI VAN (3500KG)	244	9.3	9.2	8.2	8	11.1
317.36 CDI VAN (3500KG)	245	9.3	9.3	8.2	8.1	11.1
314.43 CDI VAN Long (3500KG)	288	11	10.1	9.4	9.2	13.7
315.43 CDI VAN Long (3500KG)	251	9.6	9.6	8.5	8.3	11.4
316.43 CDI VAN Long (3500KG)	288	11	10.5	9.5	9.3	13.4
317.43 CDI VAN Long (3500KG)	253	9.6	9.6	8.6	8.4	11.3
317.43 CDI VAN Long (3500KG) A/T	263	10	10.6	9.1	8.8	11.5
319.43 CDI VAN Long (3500KG) A/T	327	12.5	14	11.4	10.9	13.8
314.43 CDI VAN Extra Long (3500KG)	288	11	10.1	9.4	9.2	13.7
315.43 CDI VAN Extra Long (3500KG)	252	9.6	9.6	8.5	8.3	11.4
316.43 CDI VAN Extra Long (3500KG)	288	11	10.5	9.5	9.3	13.4
317.43 CDI VAN Extra Long (3500KG)	253	9.7	9.7	8.6	8.4	11.4
319.43 CDI VAN Extra Long (3500KG) A/T	327	12.5	14	11.4	10.9	13.8
414 - 43 CDI VAN (4100KG)	293	11.2	10.5	9.5	9.8	13.5
417 - 43 CDI VAN (4100KG)	245	9.3	10	8.9	8.5	9.9
419 - 43 CDI VAN (4100KG)	327	12.5	14	11.4	10.9	13.8

Euro 6d-TEMP

Model	Emissions	Combined	Low Speed	Medium Speed	High Speed	Extra High Speed
	CO ₂ g/km	L/100km	L/100km	L/100km	L/100km	L/100km
RWD						
414 - 43 CDI VAN (4600KG)						
416 - 43 CDI VAN (4600KG)						
514 - 43 CDI VAN (3500KG)						
516 - 43 CDI VAN (3500KG)						
519 - 43 CDI VAN (3500KG) A/T						
519 - 36 CDI VAN (3500KG) A/T						
514 - 43 CDI VAN (4600KG)						
516 - 43 CDI VAN (4600KG)						
519 - 43 CDI VAN (4600KG) A/T						
514 - 43 CDI VAN (5000KG)						
516 - 43 CDI VAN (5000KG)						
519 - 43 CDI VAN (5000KG) A/T						
514 - 43 CDI VAN (5500KG)						
516 - 43 CDI VAN (5500KG)						
519 - 43 CDI VAN (5500KG) A/T						
514 - 43 CDI VAN extra long (3500KG)						
516 - 43 CDI VAN (3500KG)						
519 - 43 CDI VAN (3500KG) A/T						
514 - 43 CDI VAN (5000KG)						
516 - 43 CDI VAN (5000KG)						
519 - 43 CDI VAN (5000KG) A/T						
514 - 43 CDI VAN (5500KG)						
516 - 43 CDI VAN (5500KG)						
519 - 43 CDI VAN (5500KG) A/T						

Coming soon.

All figures are based on a standard specification. The choice of wheels and transmission may affect CO₂ emissions and corresponding Road Fund Licence. The indicated values were determined according to the prescribed measurement method - Worldwide Harmonised Light Vehicle Test Procedure (WLTP). Figures shown may include options which are not available in Ireland. Figures shown are for comparability purposes; only compare with other vans tested to the same technical procedures. Figures may not reflect real life driving results, which will depend upon a number of factors including factory-fitted options, accessories fitted (post registration), variations in weather, driving styles and vehicle load. Further information about the test used to establish fuel consumption and CO₂ figures can be found at <https://www.mercedes-benz.ie/vans/en/WLTP>

Weights and payloads.

Euro VI

Model	Kerb weight (kg)	Gross Vehicle Weight (kg)	Payload (kg)	Gross Train Weight (kg)
Panel Van - PROGRESSIVE				
419 - 43 CDI VAN (4100KG)	2498	4100	1602	6100
414 - 43 CDI VAN (4600KG)	2587	4600	2013	6600
416 - 43 CDI VAN (4600KG)	2587	4600	2013	6600
514 - 43 CDI VAN (3500KG)	2621	3500	879	5500
516 - 43 CDI VAN (3500KG)	2621	3500	879	5500
519 - 43 CDI VAN (3500KG) A/T	2654	3500	846	5500
519 - 36 CDI VAN (3500KG) A/T	2508	3500	992	5500
514 - 43 CDI VAN (4600KG)	2629	4600	1971	6600
516 - 43 CDI VAN (4600KG)	2629	4600	1971	6600
519 - 43 CDI VAN (4600KG) A/T	2671	4600	1929	6600
514 - 43 CDI VAN (5000KG)	2629	5000	2371	7000
516 - 43 CDI VAN (5000KG)	2629	5000	2371	7000
519 - 43 CDI VAN (5000KG) A/T	2671	5000	2329	7000
514 - 43 CDI VAN (5500KG)	2660	5500	2840	7000
516 - 43 CDI VAN (5500KG)	2660	5500	2840	7000
519 - 43 CDI VAN (5500KG) A/T	2702	5500	2798	7000
514 - 43 Extra long CDI VAN (3500KG)	2656	3500	844	5500
516 - 43 CDI VAN (3500KG)	2656	3500	844	5500
519 - 43 CDI VAN (3500KG) A/T	2689	3500	811	5500
514 - 43 CDI VAN (5000KG)	2664	5000	2336	7000
516 - 43 CDI VAN (5000KG)	2664	5000	2336	7000
519 - 43 CDI VAN (5000KG) A/T	2706	5000	2294	7000
514 - 43 CDI VAN (5500KG)	2695	5500	2805	7000
516 - 43 CDI VAN (5500KG)	2695	5500	2805	7000
519 - 43 CDI VAN (5500KG) A/T	2737	5500	2763	7000
319 CDi Van L3 H2 RWD	2,492	3,500	1,008	5,500
319 CDi Van L4 H2 RWD	2,539	5,000	961	7,000
514 CDi Van L2 H2 RWD	2,492	5,000	2,508	7,000
514 CDi Van L3 H2 RWD	2,656	5,000	2,344	7,000
514 CDi Van L4 H2 RWD	2,702	5,000	2,298	7,000
516 CDi Van L2 H2 RWD	2,492	5,000	2,508	7,000
516 CDi Van L3 H2 RWD	2,656	5,000	2,344	7,000
516 CDi Van L4 H2 RWD	2,702	5,000	2,298	7,000
519 CDi Van L2 H2 RWD	2,525	5,000	2,475	7,000
519 CDi Van L3 H2 RWD	2,689	5,000	2,311	7,000
519 CDi Van L4 H2 RWD	2,735	5,000	2,265	7,000

Dimensions.

STANDARD, STANDARD ROOF, REAR WHEEL DRIVE - PANEL VAN

Wheelbase	Wheelbase length	3,665mm
	Turning circle	13.3m
	Front track width	1,726mm
	Rear track width	1,732mm
Vehicle	Length	5,932mm
	Height (unladen)	2,361mm
	Width (inc. wing mirrors)	2,345mm
	Ground clearance	188mm
Load compartment	Load floor length	3,375mm
	Max. width	1,787mm
	Width between wheel arches	1,350mm
	Height	1,719mm
	Rear loading height (step height from ground to load floor)	657mm

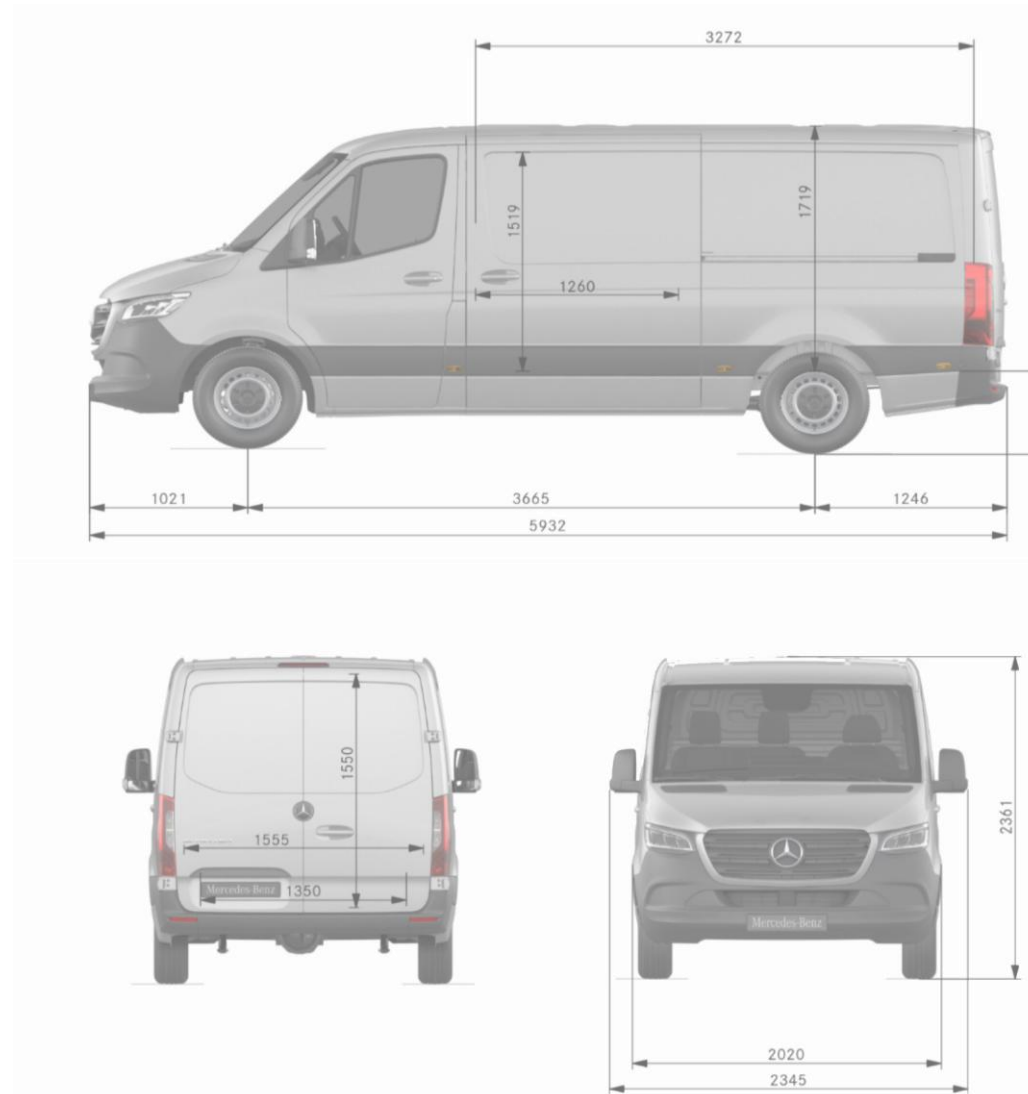

Dimensions.

STANDARD, HIGH ROOF, REAR WHEEL DRIVE – PANEL VAN*

Wheelbase	Wheelbase length	3,665mm
	Turning circle	13.3m
	Front track width	1,726mm
	Rear track width	1,732mm
Vehicle	Length	5,932mm
	Height (unladen)	2,650mm
	Width (inc. wing mirrors)	2,345mm
	Ground clearance	188mm
Load compartment	Load floor length	3,375mm
	Max. width	1,787mm
	Width between wheel arches	1,350mm
	Height	2,009mm
	Rear loading height (step height from ground to load floor)	656mm

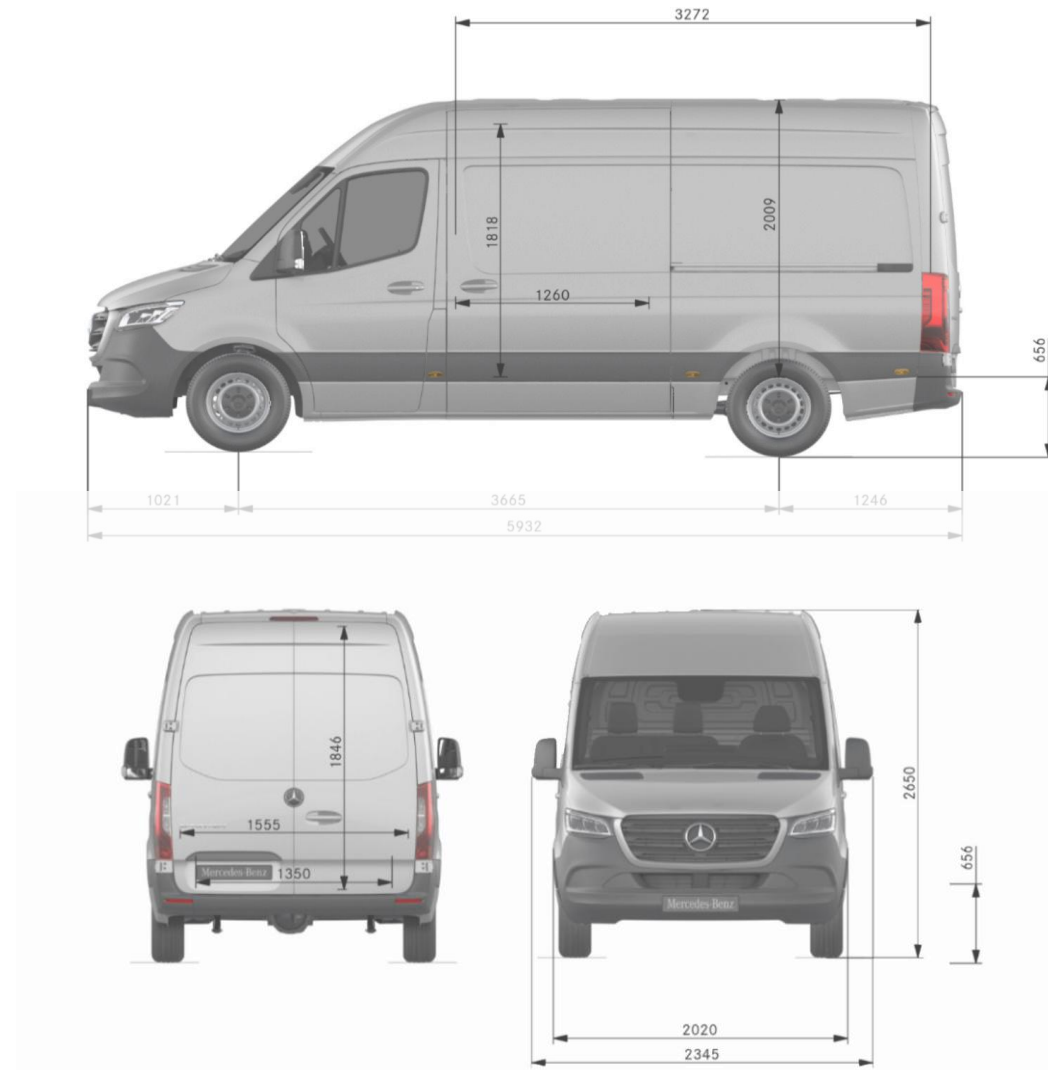

Dimensions.

LONG, HIGH ROOF, REAR WHEEL DRIVE – PANEL VAN*

Wheelbase	Wheelbase length	4,325mm
	Turning circle	15.3m
	Front track width	1,726mm
	Rear track width	1,732mm
Vehicle	Length	6,967mm
	Height (unladen)	2,646mm
	Width (inc. wing mirrors)	2,345mm
	Ground clearance	188mm
Load compartment	Load floor length	4,410mm
	Max. width	1,787mm
	Width between wheel arches	1,350mm
	Height	2,009mm
	Rear loading height (step height from ground to load floor)	651mm

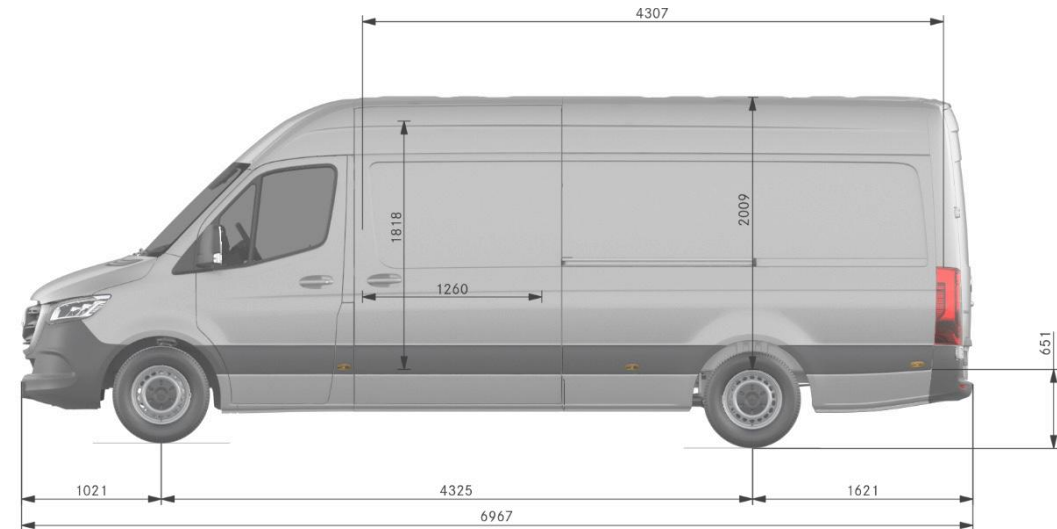

Dimensions.

EXTRA LONG, HIGH ROOF, REAR WHEEL DRIVE – PANEL VAN*

Wheelbase	Wheelbase length	4,325mm
	Turning circle	15.3m
	Front track width	1,726mm
	Rear track width	1,732mm
Vehicle	Length	7,367mm
	Height (unladen)	2,643mm
	Width (inc. wing mirrors)	2,345mm
	Ground clearance	188mm
Load compartment	Load floor length	4,810mm
	Max. width	1,787mm
	Width between wheel arches	1,350mm
	Height	2,009mm
	Rear loading height (step height from ground to load floor)	647mm

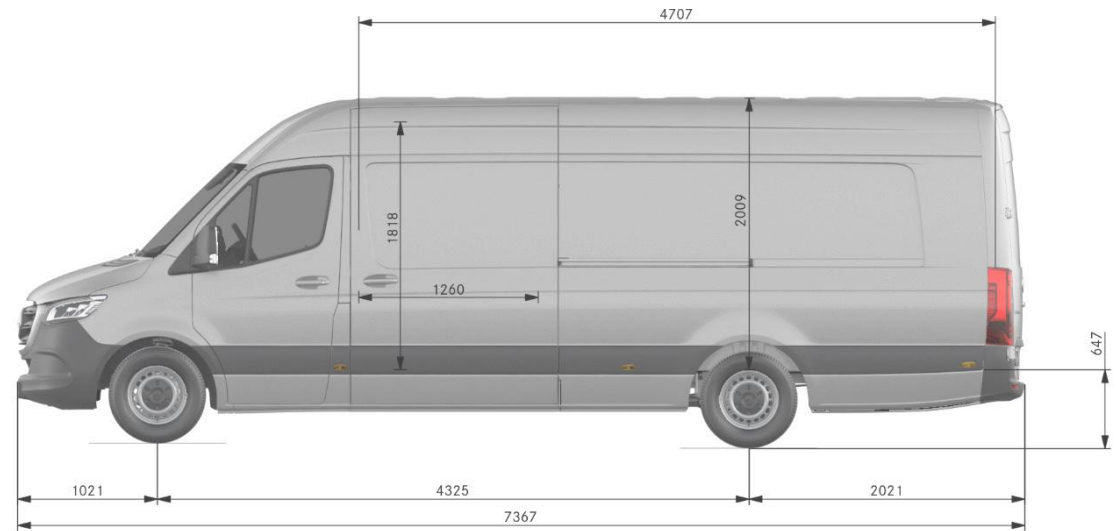

Dimensions.

LONG CHASSIS, REAR WHEEL DRIVE

Wheelbase	Wheelbase length	4,325mm
	Turning circle	15.3m
	Front track width	1,726mm
	Rear track width	1,732mm
Vehicle	Length	6,696mm
	Height (unladen)	2,311mm
	Width (inc. wing mirrors)	2,345mm
	Ground clearance	188mm

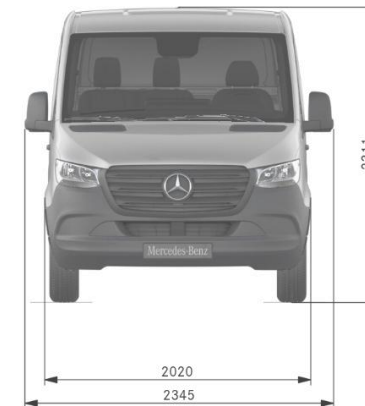
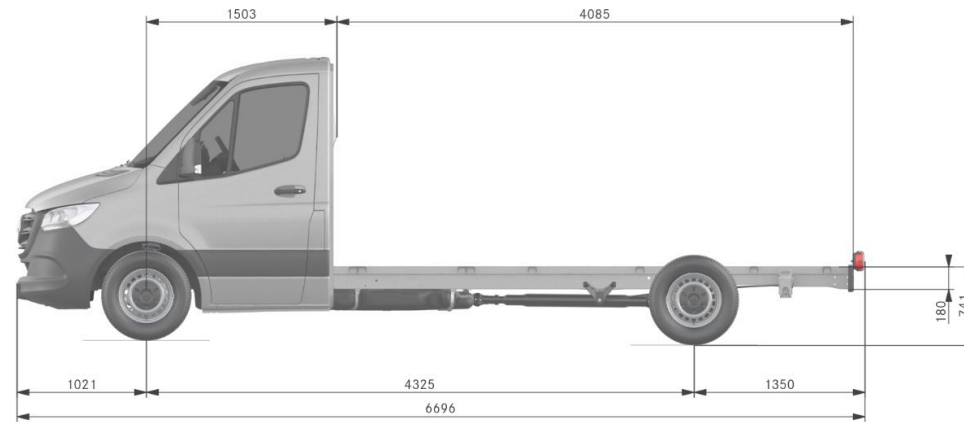

List prices - Sprinter Panel Van.

Model	Transmission	BASE	PRO	SELECT
311.36 3.5t (LOW ROOF) S	6-speed (manual)	€50,920	€53,445	-
311.43 3.5t (HIGH ROOF) L	6-speed (manual)	€54,450	€56,975	-
311.43 3.5t (HIGH ROOF) E	6-speed (manual)	€54,950	€57,475	-
315.36 3.5t (LOW ROOF) S	6-speed (manual)	€53,520	€56,045	€56,690
315.43 3.5t (HIGH ROOF) L	6-speed (manual)	€57,050	€59,575	€63,265
315.43 3.5t (HIGH ROOF) E	6-speed (manual)	€57,550	€60,075	€63,765
317.36 3.5t (LOW ROOF) S	6-speed (manual)	€54,340	€56,865	€57,510
317.43 3.5t (HIGH ROOF) L	6-speed (manual)	€57,870	€60,395	€64,085
317.43 3.5t (HIGH ROOF) E	6-speed (manual)	€58,370	€60,895	€64,585
319.36 3.5t (LOW ROOF) S	6-speed (manual)	-	€58,970	€59,615
319.43 3.5t (HIGH ROOF) L	6-speed (manual)	-	€62,500	€66,190
319.43 3.5t (HIGH ROOF) E	6-speed (manual)	-	€63,000	€66,690
319.36 VAN 4x4 3.5t (LOW ROOF) S		-	-	€67,960
319.36 VAN 4x4 3.5t (LOW ROOF) L		-	-	€74,540

S=standard wheelbase, 3665mm
L=long wheelbase, 4325mm
E=extra-long wheelbase, 4325mm

This document is for guidance only and must be used in conjunction with a configuration tool prior to final specification decisions and vehicle quotations being prepared and accepted. List prices are quoted ex-factory & ex-VAT unless otherwise stated. Delivery charges excluding VAT will be added to model prices quoted in this document. Prices based on standard finish paint choice. Mercedes-Benz Vans IE and authorised Dealers reserve the right to alter specification and vary prices without notice. The availability of options may depend on the chosen base vehicle and other optional equipment specified, and should be confirmed with your Mercedes-Benz Vans Dealer prior to order placement. VAT is calculated at the standard rate of 23%.

Model	Transmission	BASE	PRO	SELECT
515.36 5.0t (LOW ROOF) S	6-speed (manual)	€61,640	€64,160	€67,850
515.43 5.0t (High ROOF) L	6-speed (manual)	€65,165	€67,690	€71,380
515.43 3.5t (High ROOF) E	6-speed (manual)	€65,665	€68,190	€71,880
517.36 5.0t (LOW ROOF) S	6-speed (manual)	€62,455	€64,980	€68,670
517.36 5.0t (HIGH ROOF) L	6-speed (manual)	€65,985	€68,510	€72,200
517.36 5.0t (HIGH ROOF) L	6-speed (manual)	€66,485	€69,010	€72,700
519.36 5.0t (LOW ROOF) S	6-speed (manual)	-	€67,085	€70,775
519.43 5.0t (HIGH ROOF) L	6-speed (manual)	-	€72,180	€75,870
517.43 5.0t (HIGH ROOF) E	6-speed (manual)	-	€71,115	€74,805

List prices - Sprinter Chassis Cab.

Model	Transmission	BASE	PRO	SELECT
315.43 3.5t L	6-speed (manual)	€54,345	€57,005	€60,500
317.43 3.5t L	6-speed (manual)	€55,230	€57,885	€61,385
319.43 3.5t L	6-speed (manual)	-	€60,150	€63,645

Model	Transmission	BASE	PRO	SELECT
515.43 3.5t L	6-speed (manual)	€58,890	€61,550	€65,050
515.43 5.0t L	6-speed (manual)	€62,130	€64,790	€68,290
517.43 3.5t L	6-speed (manual)	€59,775	€62,435	€65,930
517.43 5.0t L	6-speed (manual)	€63,015	€65,675	€69,170
519.43 3.5t L	6-speed (manual)	-	€64,695	€68,195
519.43 5.0t L	6-speed (manual)	-	€67,935	€71,430

This document is for guidance only and must be used in conjunction with a configuration tool prior to final specification decisions and vehicle quotations being prepared and accepted. List prices are quoted ex-factory & ex-VAT unless otherwise stated. Delivery charges excluding VAT will be added to model prices quoted in this document. Prices based on standard finish paint choice. Mercedes-Benz Vans IE and authorised Dealers reserve the right to alter specification and vary prices without notice. The availability of options may depend on the chosen base vehicle and other optional equipment specified, and should be confirmed with your Mercedes-Benz Vans Dealer prior to order placement. VAT is calculated at the standard rate of 23%.

List prices – Sprinter Tourer.

Model	Transmission	SELECT
319.36 CDI Low Roof	6-speed (manual)	€136,690.00
319.36 CDI High Roof	6-speed (manual)	€139,715.00
319.43 CDI L High Roof	6-speed (manual)	€143,625.00

Includes Metallic
Paint

Note: VRT @ 41% 9
seats or less

This document is for guidance only and must be used in conjunction with a configuration tool prior to final specification decisions and vehicle quotations being prepared and accepted. List prices are quoted ex-factory & ex-VAT unless otherwise stated. Delivery charges excluding VAT will be added to model prices quoted in this document. Prices based on standard finish paint choice. Mercedes-Benz Vans IE and authorised Dealers reserve the right to alter specification and vary prices without notice. The availability of options may depend on the chosen base vehicle and other optional equipment specified, and should be confirmed with your Mercedes-Benz Vans Dealer prior to order placement. VAT is calculated at the standard rate of 23%.

After sales.

Keeping Businesses Moving.

Once you've driven away in your new Sprinter, the support we provide doesn't stop there. Did you know we offer a number of ways to keep your business moving long into the future? It's perhaps one of our best kept secrets...

› ServiceCare

Because you don't stop, we don't either. We offer a range of servicing options to suit every business and to keep your vehicles on the road and running at their peak performance.

- All new Mercedes-Benz Vans purchased from 1st July 2020 now come with a free Service Plan. This Service Plan will cover an A+B service and depending on mileage may extend your service intervals for up to 2 years.
- As part of this Service Plan, you will also receive a complimentary Mercedes Pro connect activation. This activation will allow you to stay connected with your vehicle by phone, tablet or desktop device.

[Find out more about service and repairs](#)

› MobiloVan

All Mercedes-Benz Vans come with MobiloVan, our free roadside assistance 24/7, across Europe. If you breakdown, have a collision or can't start your van, call MobiloVan and a technician with an average response time of under 60 minutes will arrive in a van stocked with Mercedes-Benz GenuineParts. With an average roadside repair rate of 80%, you'll be moving again in no time.

› 3 year warranty

Because we want to help keep businesses moving today and in the future, all our new and Approved Used vans come with a free 3 year unlimited mileage warranty.

› 24/7 Dealer network

Our nationwide network of approved Dealers is here to help your business maintain momentum.

<https://mercedesdealersearch2015.webzone.ie/contentv3/>

